

BOUTON CREUX TARAUDE EN THERMOPLAST

H.24750

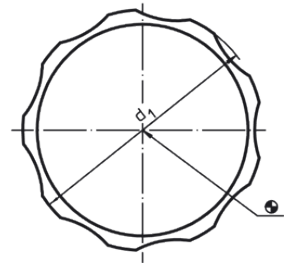

MATIERE ET EXECUTION :
 Bouton creux en thermoplast PA 6 noir RAL 9005 – exécution légère.
 Bague taraudée en INOX.
 Couvreclerc interchangeable en thermoplast de différentes couleurs :
 noir – RAL 9005.
 blanc – RAL 9019
 orange – RAL 2004
 jaune – RAL 1016
 bleu – RAL 5015

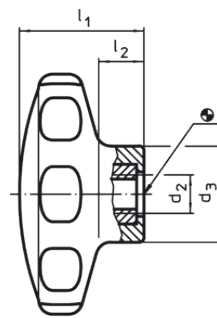

Ø d1	d2	Ø d3	l1	l2	Ref.				
					noir RAL 9005	blanc RAL 9019	orange RAL 2004	jaune RAL 1016	bleu ral 5015
30	M4	14,0	19	7	H.24750.0030	H.24750.0031	H.24750.0032	H.24750.0033	H.24750.0034
30	M5	14,0	19	7	H.24750.0035	H.24750.0036	H.24750.0037	H.24750.0038	H.24750.0039
40	M5	16,5	22	9	H.24750.0040	H.24750.0041	H.24750.0042	H.24750.0043	H.24750.0044
40	M6	16,5	22	9	H.24750.0045	H.24750.0046	H.24750.0047	H.24750.0048	H.24750.0049
50	M6	22,0	26	10	H.24750.0050	H.24750.0051	H.24750.0052	H.24750.0053	H.24750.0054
50	M8	22,0	26	10	H.24750.0055	H.24750.0056	H.24750.0057	H.24750.0058	H.24750.0059
62	M8	22,0	35	13	H.24750.0060	H.24750.0061	H.24750.0062	H.24750.0063	H.24750.0064
62	M10	22,0	35	13	H.24750.0065	H.24750.0066	H.24750.0067	H.24750.0068	H.24750.0069

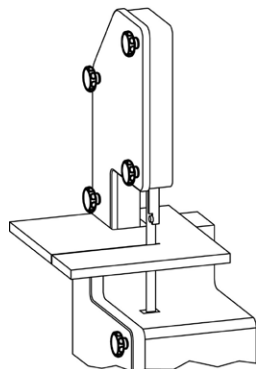

BOUTON CREUX EN THERMOPLAST AVEC TIGE FILETEE

H.24750

MATIERE ET EXECUTION :

Bouton creux en thermoplast PA 6 noir RAL 9005 – exécution légère.

Tige filetée en INOX.

Couvercle interchangeable en thermoplast de différentes couleurs :

noir – RAL 9005.

blanc – RAL 9019

orange – RAL 2004

jaune – RAL 1016

bleu – RAL 5015

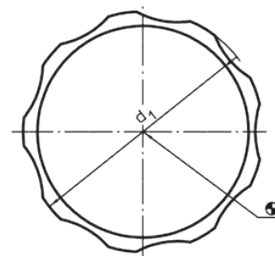
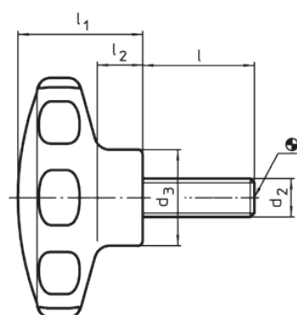

Ø d1	d2	l	Ø d3	l1	l2	Ref.				
						noir RAL 9005	blanc RAL 9019	orange RAL 2004	jaune RAL 1016	bleu ral 5015
30	M4	10	14,0	19	7	H.24750.0100	H.24750.0101	H.24750.0102	H.24750.0103	H.24750.0104
30	M4	14	14,0	19	7	H.24750.0110	H.24750.0111	H.24750.0112	H.24750.0113	H.24750.0114
30	M4	18	14,0	19	7	H.24750.0120	H.24750.0121	H.24750.0122	H.24750.0123	H.24750.0124
30	M4	23	14,0	19	7	H.24750.0130	H.24750.0131	H.24750.0132	H.24750.0133	H.24750.0134
30	M4	28	14,0	19	7	H.24750.0140	H.24750.0141	H.24750.0142	H.24750.0143	H.24750.0144
30	M5	10	14,0	19	7	H.24750.0150	H.24750.0151	H.24750.0152	H.24750.0153	H.24750.0154
30	M5	14	14,0	19	7	H.24750.0160	H.24750.0161	H.24750.0162	H.24750.0163	H.24750.0164
30	M5	18	14,0	19	7	H.24750.0170	H.24750.0171	H.24750.0172	H.24750.0173	H.24750.0174
30	M5	23	14,0	19	7	H.24750.0180	H.24750.0181	H.24750.0182	H.24750.0183	H.24750.0184
30	M5	28	14,0	19	7	H.24750.0190	H.24750.0191	H.24750.0192	H.24750.0193	H.24750.0194
40	M5	10	16,5	22	9	H.24750.0200	H.24750.0201	H.24750.0202	H.24750.0203	H.24750.0204
40	M5	14	16,5	22	9	H.24750.0210	H.24750.0211	H.24750.0212	H.24750.0213	H.24750.0214
40	M5	18	16,5	22	9	H.24750.0220	H.24750.0221	H.24750.0222	H.24750.0223	H.24750.0224
40	M5	23	16,5	22	9	H.24750.0230	H.24750.0231	H.24750.0232	H.24750.0233	H.24750.0234
40	M5	28	16,5	22	9	H.24750.0240	H.24750.0241	H.24750.0242	H.24750.0243	H.24750.0244
40	M6	14	16,5	22	9	H.24750.0250	H.24750.0251	H.24750.0252	H.24750.0253	H.24750.0254
40	M6	18	16,5	22	9	H.24750.0260	H.24750.0261	H.24750.0262	H.24750.0263	H.24750.0264
40	M6	23	16,5	22	9	H.24750.0270	H.24750.0271	H.24750.0272	H.24750.0273	H.24750.0274
40	M6	28	16,5	22	9	H.24750.0280	H.24750.0281	H.24750.0282	H.24750.0283	H.24750.0284
40	M6	38	16,5	22	9	H.24750.0290	H.24750.0291	H.24750.0292	H.24750.0293	H.24750.0294

BOUTON CREUX EN THERMOPLAST AVEC TIGE FILETEE

H.24750
MATIERE ET EXECUTION :

Bouton creux en thermoplast PA 6 noir RAL 9005 – exécution légère.

Tige filetée en INOX.

Couvercle interchangeable en thermoplast de différentes couleurs :

noir – RAL 9005.

blanc – RAL 9019

orange – RAL 2004

jaune – RAL 1016

bleu – RAL 5015

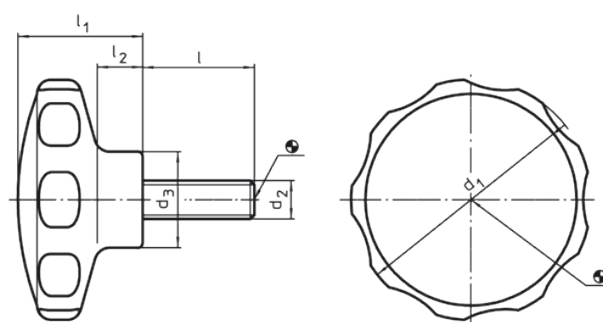

Ø d1	d2	l	Ø d3	l1	l2	Ref.				
						noir RAL 9005	blanc RAL 9019	orange RAL 2004	jaune RAL 1016	bleu ral 5015
50	M6	14	22,0	26	10	H.24750.0300	H.24750.0301	H.24750.0302	H.24750.0303	H.24750.0304
50	M6	18	22,0	26	10	H.24750.0310	H.24750.0311	H.24750.0312	H.24750.0313	H.24750.0314
50	M6	23	22,0	26	10	H.24750.0320	H.24750.0321	H.24750.0322	H.24750.0323	H.24750.0324
50	M6	28	22,0	26	10	H.24750.0330	H.24750.0331	H.24750.0332	H.24750.0333	H.24750.0334
50	M6	38	22,0	26	10	H.24750.0340	H.24750.0341	H.24750.0342	H.24750.0343	H.24750.0344
50	M8	18	22,0	26	10	H.24750.0350	H.24750.0351	H.24750.0352	H.24750.0353	H.24750.0354
50	M8	23	22,0	26	10	H.24750.0360	H.24750.0361	H.24750.0362	H.24750.0363	H.24750.0364
50	M8	28	22,0	26	10	H.24750.0370	H.24750.0371	H.24750.0372	H.24750.0373	H.24750.0374
50	M8	38	22,0	26	10	H.24750.0380	H.24750.0381	H.24750.0382	H.24750.0383	H.24750.0384
50	M8	48	22,0	26	10	H.24750.0390	H.24750.0391	H.24750.0392	H.24750.0393	H.24750.0394
62	M8	18	22,0	35	13	H.24750.0400	H.24750.0401	H.24750.0402	H.24750.0403	H.24750.0404
62	M8	23	22,0	35	13	H.24750.0410	H.24750.0411	H.24750.0412	H.24750.0413	H.24750.0414
62	M8	28	22,0	35	13	H.24750.0420	H.24750.0421	H.24750.0422	H.24750.0423	H.24750.0424
62	M8	38	22,0	35	13	H.24750.0430	H.24750.0431	H.24750.0432	H.24750.0433	H.24750.0434
62	M8	48	22,0	35	13	H.24750.0440	H.24750.0441	H.24750.0442	H.24750.0443	H.24750.0444
62	M10	23	22,0	35	13	H.24750.0450	H.24750.0451	H.24750.0452	H.24750.0453	H.24750.0454
62	M10	28	22,0	35	13	H.24750.0460	H.24750.0461	H.24750.0462	H.24750.0463	H.24750.0464
62	M10	38	22,0	35	13	H.24750.0470	H.24750.0471	H.24750.0472	H.24750.0473	H.24750.0474
62	M10	48	22,0	35	13	H.24750.0480	H.24750.0481	H.24750.0482	H.24750.0483	H.24750.0484
62	M10	58	22,0	35	13	H.24750.0490	H.24750.0491	H.24750.0492	H.24750.0493	H.24750.0494

BOUTON ETOILE EN POLYAMIDE

BK



Uniquement pour grandes quantités : 1.000 - 10.000 pièces.

Bouton creux ou massif, avec ou sans couvercle, avec bague taraudée en acier zingué.

Dimensions livrables :

Ø 30 - M5 / 6 / 8

Ø 40 - M6 / 8

Ø 50 - M6 / 8 / 10

Ø 62 - M8 / 10 / 12

Couleurs : noir, orange, bleu, jaune, rouge, vert, gris.

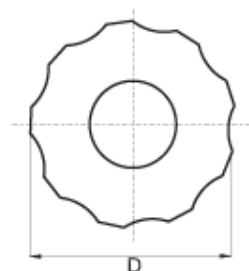
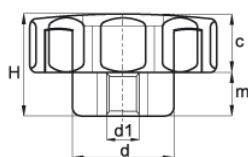

BOUTON ETOILE EN POLYAMIDE

BK



Uniquement pour grandes quantités : 1.000 - 10.000 pièces.

Bouton creux ou massif, avec couvercle et tige filetée en acier zingué.

Dimensions livrables :

Ø 30 - M5 / 6 / 8 - longueur de vis : 10 à 58 mm

Ø 40 - M6 / 8 - longueur de vis : 10 à 58 mm

Ø 50 - M8 / 10 - longueur de vis : 10 à 68 mm

Ø 62 - M8 / 10 / 12 - longueur de vis : 10 à 68 mm

Couleurs : noir, orange, bleu, jaune, rouge, vert, gris

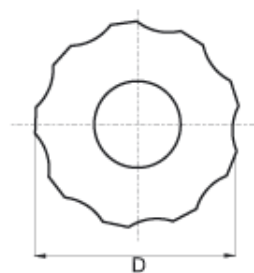
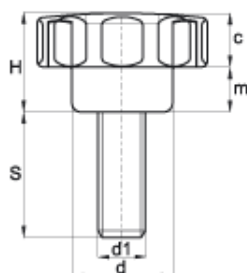

BOUTON CRUCIFORME EN POLYAMIDE

BKE



Uniquement pour grandes quantités : 1.000 - 10.000 pièces.

Avec ou sans couvercle - Ø 40 mm.

Avec bague taraudée en acier zingué : M6 / 8

Avec tige filetée en acier zingué : M6 / 8 – longueur de vis : 10 à 58 mm.

Couleurs au choix pour couvercle et / ou bouton :

noir, orange, bleu, jaune, rouge, vert, gris.

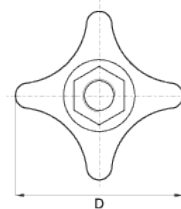
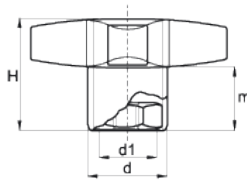
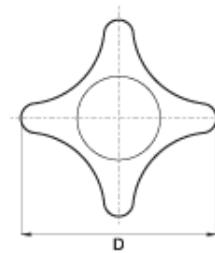
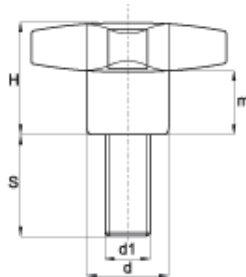

BOUTON A LOBES EN POLYAMIDE

BKE



Uniquement pour grandes quantités : 1.000 - 10.000 pièces.

Avec ou sans couvercle – Ø 31 mm.

Avec bague taraudée en acier zingué : M6 / 8.

Avec tige filetée en acier zingué : M6 / 8 – longueur de vis : 10 à 58 mm.

Couleurs au choix pour couvercle et / ou bouton :
noir, orange, bleu, jaune, rouge, vert gris.

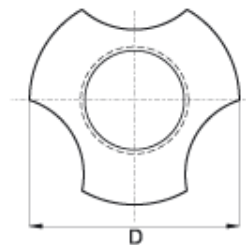
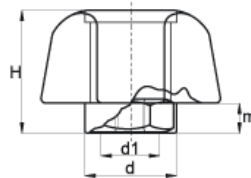
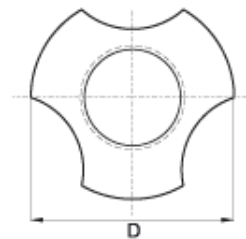
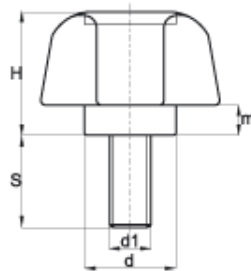

BOUTON PAPILLON EN POLYAMIDE

BKE



Uniquement pour grandes quantités : 1.000 - 10.000 pièces.

Avec ou sans couvercle, avec bague taraudée en acier zingué.

Longueur corps : 28 mm – M5

Longueur corps : 38 mm – M5 / 6

Longueur corps : 48 mm – M6 / 8

Longueur corps : 68 mm – M6 / 8

Couleurs au choix pour couvercle et / ou bouton :

noir, orange, bleu, jaune, rouge, vert, gris.

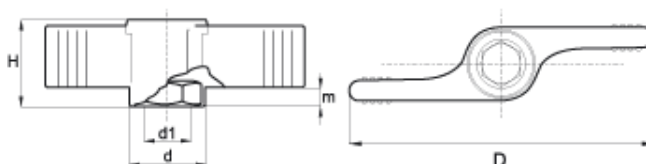

BOUTON PAPILLON EN POLYAMIDE

BKE



Uniquement pour grandes quantités : 1.000 - 10.000 pièces.

Avec couvercle et tige filetée en acier zingué.

Longueur corps : 28 mm – M5 – longueur de vis : 8 à 48 mm

Longueur corps : 38 mm – M5 / 6 – longueur de vis : 8 à 58 mm

Longueur corps : 48 mm – M6 / 8 – longueur de vis : 8 à 58 mm

Longueur corps : 68 mm – M6 / 8 – longueur de vis : 8 à 58 mm

Couleurs au choix pour couvercle et / ou bouton :

noir, orange, bleu, jaune, rouge, vert, gris.

