

HOLLE GETAPTE KNOP UIT THERMOPLAST

H.24750

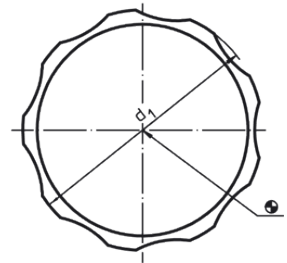

MATERIAAL EN UITVOERING :
 Holle knop uit zwarte thermoplast PA6 - RAL 9005 – lichte uitvoering.
 Getapte bus uit RVS.
 Uitwisselbare dop uit thermoplast met verschillende kleuren :
 zwart – RAL 9005.
 wit – RAL 9019
 oranje – RAL 2004
 geel – RAL 1016
 blauw – RAL 5015

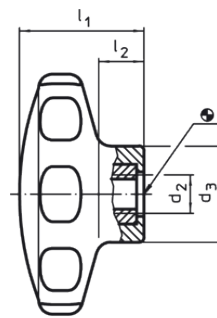

Ø d1	d2	Ø d3	l1	l2	Ref.				
					zwart RAL 9005	wit RAL 9019	oranje RAL 2004	geel RAL 1016	blauw ral 5015
30	M4	14,0	19	7	H.24750.0030	H.24750.0031	H.24750.0032	H.24750.0033	H.24750.0034
30	M5	14,0	19	7	H.24750.0035	H.24750.0036	H.24750.0037	H.24750.0038	H.24750.0039
40	M5	16,5	22	9	H.24750.0040	H.24750.0041	H.24750.0042	H.24750.0043	H.24750.0044
40	M6	16,5	22	9	H.24750.0045	H.24750.0046	H.24750.0047	H.24750.0048	H.24750.0049
50	M6	22,0	26	10	H.24750.0050	H.24750.0051	H.24750.0052	H.24750.0053	H.24750.0054
50	M8	22,0	26	10	H.24750.0055	H.24750.0056	H.24750.0057	H.24750.0058	H.24750.0059
62	M8	22,0	35	13	H.24750.0060	H.24750.0061	H.24750.0062	H.24750.0063	H.24750.0064
62	M10	22,0	35	13	H.24750.0065	H.24750.0066	H.24750.0067	H.24750.0068	H.24750.0069

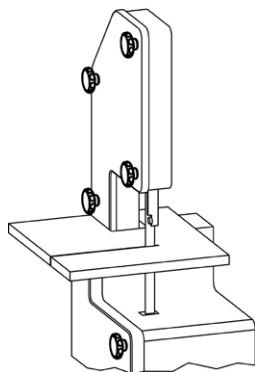

HOLLE KNOP UIT THERMOPLAST MET DRAADSTANG

H.24750

MATERIAAL EN UITVOERING :

Holle knop uit zwarte thermoplast PA6 - RAL 9005 – lichte uitvoering;
Schroef uit RVS.

Uitwisselbare dop uit thermoplast met verschillende kleuren :

zwart – RAL 9005.

wit – RAL 9019

oranje – RAL 2004

geel – RAL 1016

blauw – RAL 5015

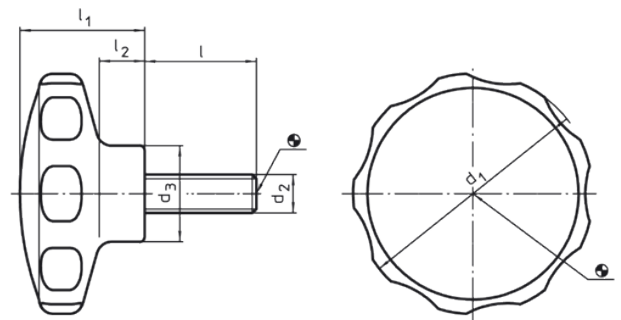

Ø d1	d2	l	Ø d3	l1	l2	Ref.				
						zwart RAL 9005	wit RAL 9019	oranje RAL 2004	geel RAL 1016	blauw ral 5015
30	M4	10	14,0	19	7	H.24750.0100	H.24750.0101	H.24750.0102	H.24750.0103	H.24750.0104
30	M4	14	14,0	19	7	H.24750.0110	H.24750.0111	H.24750.0112	H.24750.0113	H.24750.0114
30	M4	18	14,0	19	7	H.24750.0120	H.24750.0121	H.24750.0122	H.24750.0123	H.24750.0124
30	M4	23	14,0	19	7	H.24750.0130	H.24750.0131	H.24750.0132	H.24750.0133	H.24750.0134
30	M4	28	14,0	19	7	H.24750.0140	H.24750.0141	H.24750.0142	H.24750.0143	H.24750.0144
30	M5	10	14,0	19	7	H.24750.0150	H.24750.0151	H.24750.0152	H.24750.0153	H.24750.0154
30	M5	14	14,0	19	7	H.24750.0160	H.24750.0161	H.24750.0162	H.24750.0163	H.24750.0164
30	M5	18	14,0	19	7	H.24750.0170	H.24750.0171	H.24750.0172	H.24750.0173	H.24750.0174
30	M5	23	14,0	19	7	H.24750.0180	H.24750.0181	H.24750.0182	H.24750.0183	H.24750.0184
30	M5	28	14,0	19	7	H.24750.0190	H.24750.0191	H.24750.0192	H.24750.0193	H.24750.0194
40	M5	10	16,5	22	9	H.24750.0200	H.24750.0201	H.24750.0202	H.24750.0203	H.24750.0204
40	M5	14	16,5	22	9	H.24750.0210	H.24750.0211	H.24750.0212	H.24750.0213	H.24750.0214
40	M5	18	16,5	22	9	H.24750.0220	H.24750.0221	H.24750.0222	H.24750.0223	H.24750.0224
40	M5	23	16,5	22	9	H.24750.0230	H.24750.0231	H.24750.0232	H.24750.0233	H.24750.0234
40	M5	28	16,5	22	9	H.24750.0240	H.24750.0241	H.24750.0242	H.24750.0243	H.24750.0244
40	M6	14	16,5	22	9	H.24750.0250	H.24750.0251	H.24750.0252	H.24750.0253	H.24750.0254
40	M6	18	16,5	22	9	H.24750.0260	H.24750.0261	H.24750.0262	H.24750.0263	H.24750.0264
40	M6	23	16,5	22	9	H.24750.0270	H.24750.0271	H.24750.0272	H.24750.0273	H.24750.0274
40	M6	28	16,5	22	9	H.24750.0280	H.24750.0281	H.24750.0282	H.24750.0283	H.24750.0284
40	M6	38	16,5	22	9	H.24750.0290	H.24750.0291	H.24750.0292	H.24750.0293	H.24750.0294

HOLLE KNOP UIT THERMOPLAST MET DRAADSTANG

H.24750
MATERIAAL EN UITVOERING :

 Holle knop uit zwarte thermoplast PA6 - RAL 9005 – lichte uitvoering;
 Schroef uit RVS.

Uitwisselbare dop uit thermoplast met verschillende kleuren :

zwart – RAL 9005.

wit – RAL 9019

oranje – RAL 2004

geel – RAL 1016

blauw – RAL 5015

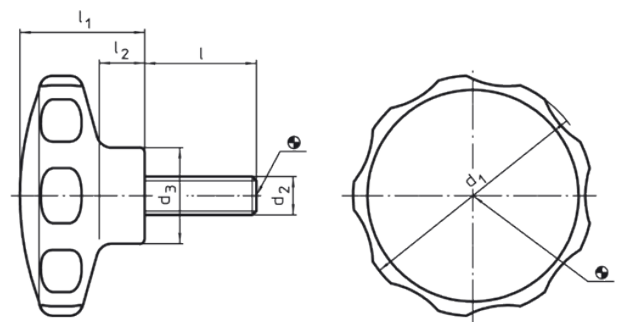

Ø d1	d2	l	Ø d3	l1	l2	Ref.				
						zwart RAL 9005	wit RAL 9019	oranje RAL 2004	geel RAL 1016	blauw ral 5015
50	M6	14	22,0	26	10	H.24750.0300	H.24750.0301	H.24750.0302	H.24750.0303	H.24750.0304
50	M6	18	22,0	26	10	H.24750.0310	H.24750.0311	H.24750.0312	H.24750.0313	H.24750.0314
50	M6	23	22,0	26	10	H.24750.0320	H.24750.0321	H.24750.0322	H.24750.0323	H.24750.0324
50	M6	28	22,0	26	10	H.24750.0330	H.24750.0331	H.24750.0332	H.24750.0333	H.24750.0334
50	M6	38	22,0	26	10	H.24750.0340	H.24750.0341	H.24750.0342	H.24750.0343	H.24750.0344
50	M8	18	22,0	26	10	H.24750.0350	H.24750.0351	H.24750.0352	H.24750.0353	H.24750.0354
50	M8	23	22,0	26	10	H.24750.0360	H.24750.0361	H.24750.0362	H.24750.0363	H.24750.0364
50	M8	28	22,0	26	10	H.24750.0370	H.24750.0371	H.24750.0372	H.24750.0373	H.24750.0374
50	M8	38	22,0	26	10	H.24750.0380	H.24750.0381	H.24750.0382	H.24750.0383	H.24750.0384
50	M8	48	22,0	26	10	H.24750.0390	H.24750.0391	H.24750.0392	H.24750.0393	H.24750.0394
62	M8	18	22,0	35	13	H.24750.0400	H.24750.0401	H.24750.0402	H.24750.0403	H.24750.0404
62	M8	23	22,0	35	13	H.24750.0410	H.24750.0411	H.24750.0412	H.24750.0413	H.24750.0414
62	M8	28	22,0	35	13	H.24750.0420	H.24750.0421	H.24750.0422	H.24750.0423	H.24750.0424
62	M8	38	22,0	35	13	H.24750.0430	H.24750.0431	H.24750.0432	H.24750.0433	H.24750.0434
62	M8	48	22,0	35	13	H.24750.0440	H.24750.0441	H.24750.0442	H.24750.0443	H.24750.0444
62	M10	23	22,0	35	13	H.24750.0450	H.24750.0451	H.24750.0452	H.24750.0453	H.24750.0454
62	M10	28	22,0	35	13	H.24750.0460	H.24750.0461	H.24750.0462	H.24750.0463	H.24750.0464
62	M10	38	22,0	35	13	H.24750.0470	H.24750.0471	H.24750.0472	H.24750.0473	H.24750.0474
62	M10	48	22,0	35	13	H.24750.0480	H.24750.0481	H.24750.0482	H.24750.0483	H.24750.0484
62	M10	58	22,0	35	13	H.24750.0490	H.24750.0491	H.24750.0492	H.24750.0493	H.24750.0494

STERKNOP UIT POLYAMIDE

BK



Enkel voor grote hoeveelheden : 1.000 - 10.000 stukken.

Holle of massieve knop, met of zonder deksel, met draadstang uit verzinkt staal.

Leverbare afmetingen :

Ø 30 mm – M5 / 6 / 8 – lengte schroef : 10 tot 58 mm

Ø 40 mm – M6 / 8 – lengte schroef : 10 tot 58 mm

Ø 50 mm – M6 / 8 / 10 – lengte schroef : 10 tot 68 mm

Ø 62 mm – M8 / 10 / 12 – lengte schroef : 10 tot 68 mm

Kleuren : zwart, oranje, blauw, geel, rood, groen, grijs.

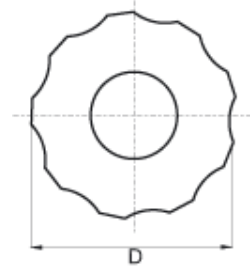
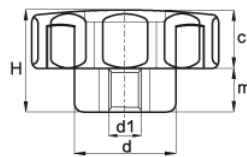

STERKNOP UIT POLYAMIDE

BK



Enkel voor grote hoeveelheden : 1.000 - 10.000 stukken.

Holle of massieve knop, met of zonder deksel, met bus met binnenschroefdraad uit verzinkt staal.

Leverbare afmetingen :

Ø 30 mm – M5 / 6 / 8

Ø 40 mm – M6 / 8

Ø 50 mm – M6 / 8 / 10

Ø 62 mm – M8 / 10 / 12

Kleuren : zwart, oranje, blauw, geel, rood, groen, grijs.

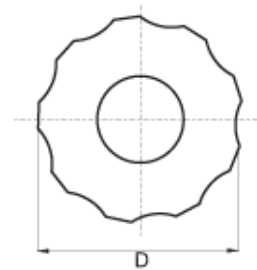
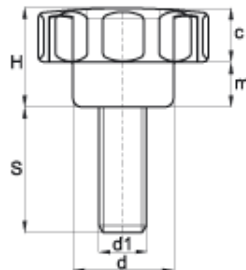

KRUISKNOP UIT POLYAMIDE

BKE



Enkel voor grote hoeveelheden : 1.000 - 10.000 stukken.

Met of zonder deksel – Ø 40 mm.

Met bus met binnenschroefdraad uit verzinkt staal – M6 / 8.

Met draadstang uit verzinkt staal : M6 / 8 – lengte schroef : 10 tot 58 mm.

Kleuren naar keuze voor deksel en / of knop :

zwart, oranje, blauw, geel, rood, groen, grijs.

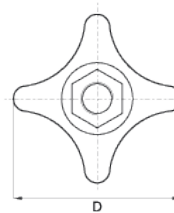
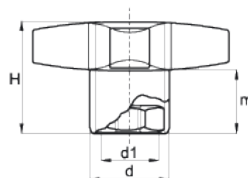
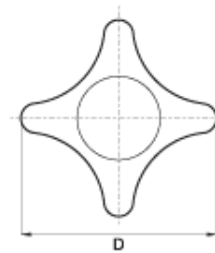
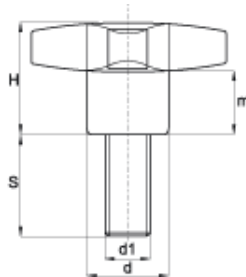

KNOP MET INKEPINGEN UIT POLYAMIDE



Enkel voor grote hoeveelheden : 1.000 - 10.000 stukken.

Met of zonder deksel – Ø 31 mm.

Met bus met binnenschroefdraad uit verzinkt staal : M6 / 8.

Met draadstang uit verzinkt staal : M6 / 8 – lengte schroef : 10 tot 58 mm.

Kleuren naar keuze voor deksel en / of knop :

zwart, oranje, blauw, geel, rood, groen, grijs.

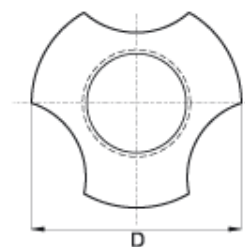
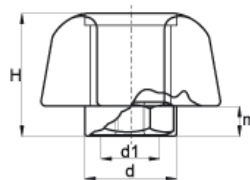
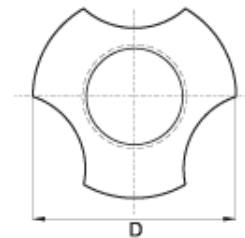
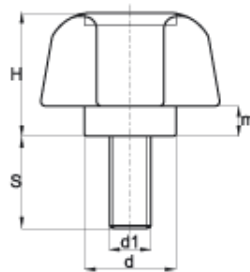

VLEUGELKNOP UIT POLYAMIDE

BKE



Enkel voor grote hoeveelheden : 1.000 - 10.000 stukken.

Met of zonder deksel, met bus met binnenschroefdraad

Lengte lichaam : 28 mm – M5

Lengte lichaam : 38 mm – M5 / 6

Lengte lichaam : 48 mm – M6 / 8

Lengte lichaam : 68 mm – M6 / 8

Kleuren naar keuze voor deksel en / of knop :

zwart, oranje, blauw, geel, rood, groen, grijs.

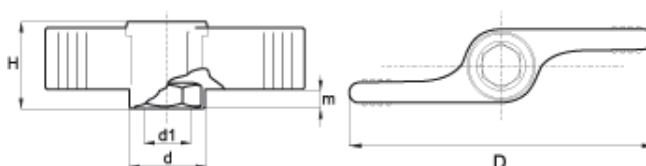

VLEUGELKNOP UIT POLYAMIDE

BKE



Enkel voor grote hoeveelheden : 1.000 - 10.000 stukken.

Met deksel en draadstang uit verzinkt staal.

Lengte lichaam : 28 mm – M5 – schroeflengte : 8 à 48 mm

Lengte lichaam : 38 mm – M5 / 6 – schroeflengte : 8 à 58 mm

Lengte lichaam : 48 mm – M6 / 8 – schroeflengte : 8 à 58 mm

Lengte lichaam : 68 mm – M6 / 8 – schroeflengte : 8 à 58 mm

Kleuren naar keuze voor deksel en / of knop :

zwart, oranje, blauw, geel, rood, groen, grijs.

