

**GRAFIET "TOYO TANSO"
ISEM 02**

Art. EDM.SG.020

soortelijk gewicht	hardheid	elekt. weerstand	mechan. weerstand	korrelgrootte
1,78 g/cm ³	55 Shore D	1100 u Ω cm	410 kgf/cm ²	10 mu

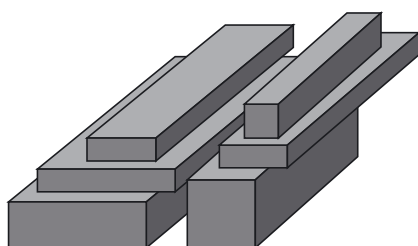

STANDAARD BLOK :
(snel leverbaar - beste prijs per dm³)

afmetingen (mm)	Art.
310 x 625 x 1010	EDM.SG.020.001
310 x 625 x 502	EDM.SG.020.004
310 x 310 x 502	EDM.SG.020.007

STANDAARD SNEDE :

afmetingen (mm)	Art.
310 x 310 x 1010	EDM.SG.020.006
152 x 625 x 1010	EDM.SG.020.009
152 x 310 x 1010	EDM.SG.020.012
152 x 152 x 1010	EDM.SG.020.015
152 x 625 x 502	EDM.SG.020.010
152 x 310 x 502	EDM.SG.020.013
152 x 152 x 502	EDM.SG.020.016
310 x 625 x 248	EDM.SG.020.005
310 x 310 x 248	EDM.SG.020.008
152 x 625 x 248	EDM.SG.020.011
152 x 310 x 248	EDM.SG.020.014
152 x 152 x 248	EDM.SG.020.017



**GRAFIET "TOYO TANSO"
ISEM 03**

Art. EDM.SG.030

soortelijk gewicht	hardheid	elekt. weerstand	mechan. weerstand	korrelgrootte
1,85 g/cm ³	60 Shore D	1000 u Ω cm	490 kgf/cm ²	10 mu

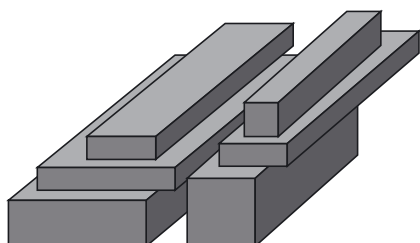

STANDAARD BLOK :
(snel leverbaar - beste prijs per dm³)

afmetingen (mm)	Art.
310 x 625 x 1500	EDM.SG.030.072
310 x 625 x 1010	EDM.SG.030.001
310 x 625 x 502	EDM.SG.030.004
310 x 310 x 502	EDM.SG.030.007

STANDAARD SNEDE :

afmetingen (mm)	Art.
310 x 310 x 1010	EDM.SG.030.006
152 x 625 x 1010	EDM.SG.030.009
152 x 310 x 1010	EDM.SG.030.012
152 x 152 x 1010	EDM.SG.030.015
152 x 625 x 502	EDM.SG.030.010
152 x 310 x 502	EDM.SG.030.013
152 x 152 x 502	EDM.SG.030.016
310 x 625 x 248	EDM.SG.030.005
310 x 310 x 248	EDM.SG.030.008
152 x 625 x 248	EDM.SG.030.011
152 x 310 x 248	EDM.SG.030.014
152 x 152 x 248	EDM.SG.030.017

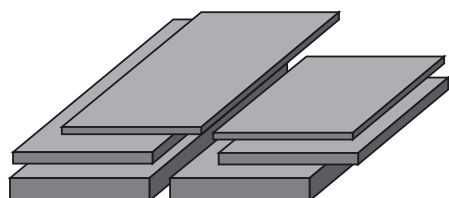

GEZAAGDE PLATEN : Tolerantie op de dikte : +0/+2 mm - 1 rechte zijde.

afmetingen (mm)	Art.
625 x 310 x 10	EDM.SG.030.032
625 x 310 x 20	EDM.SG.030.033
625 x 310 x 30	EDM.SG.030.034
625 x 310 x 40	EDM.SG.030.035
625 x 310 x 50	EDM.SG.030.036
625 x 310 x 60	EDM.SG.030.037
625 x 310 x 70	EDM.SG.030.038
625 x 310 x 80	EDM.SG.030.039
625 x 310 x 90	EDM.SG.030.040
625 x 310 x 100	EDM.SG.030.041

afmetingen (mm)	Art.
310 x 310 x 10	EDM.SG.030.042
310 x 310 x 20	EDM.SG.030.043
310 x 310 x 30	EDM.SG.030.044
310 x 310 x 40	EDM.SG.030.045
310 x 310 x 50	EDM.SG.030.046
310 x 310 x 60	EDM.SG.030.047
310 x 310 x 70	EDM.SG.030.048
310 x 310 x 80	EDM.SG.030.049
310 x 310 x 90	EDM.SG.030.050
310 x 310 x 100	EDM.SG.030.051

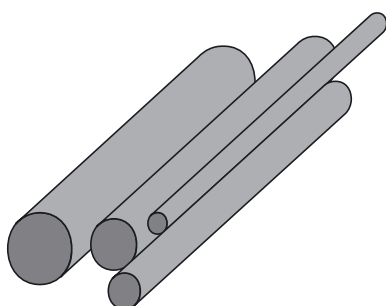

CILINDERS Ø X L = 300 mm :

Tolerantie Ø : 0/+0,2 mm. Tolerantie op de lengte : 0/+10 mm

Ø (mm)	Art.	Ø (mm)	Art.
10	EDM.SG.030.052	45	EDM.SG.030.059
15	EDM.SG.030.053	50	EDM.SG.030.060
20	EDM.SG.030.054	60	EDM.SG.030.061
25	EDM.SG.030.055	70	EDM.SG.030.062
30	EDM.SG.030.056	75	EDM.SG.030.063
35	EDM.SG.030.057	80	EDM.SG.030.064
40	EDM.SG.030.058	90	EDM.SG.030.065

Ø (mm)	Art.	Ø (mm)	Art.
100	EDM.SG.030.066	150	EDM.SG.030.069
120	EDM.SG.030.067	175	EDM.SG.030.070
125	EDM.SG.030.068	200	EDM.SG.030.071

**GRAFIET "TOYO TANSO"
ISEM 08**

Art. EDM.SG.050

soortelijk gewicht	hardheid	elekt. weerstand	mechan. weerstand	korrelgrootte
1,77 g/cm ³	65 Shore D	1450 u Ω cm	750 kgf/cm ²	8 mu

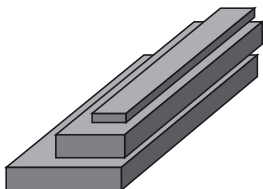

STANDAARD BLOK :

(snel leverbaar - beste prijs per dm³)

afmetingen (mm)	Art.
310 x 625 x 1200	EDM.SG.050.001
310 x 625 x 1010	EDM.SG.050.002
240 x 580 x 880	EDM.SG.050.203
310 x 625 x 502	EDM.SG.050.204
310 x 310 x 502	EDM.SG.050.207
240 x 580 x 440	EDM.SG.050.218
240 x 287 x 440	EDM.SG.050.221

STANDAARD SNEDE :

afmetingen (mm)	Art.
310 x 310 x 1010	EDM.SG.050.206
152 x 625 x 1010	EDM.SG.050.209
152 x 310 x 1010	EDM.SG.050.212
152 x 152 x 1010	EDM.SG.050.215
240 x 287 x 880	EDM.SG.050.220
117 x 580 x 880	EDM.SG.050.223
117 x 287 x 880	EDM.SG.050.226
117 x 141 x 880	EDM.SG.050.229
152 x 625 x 502	EDM.SG.050.210
152 x 310 x 502	EDM.SG.050.213
152 x 152 x 502	EDM.SG.050.216
117 x 580 x 440	EDM.SG.050.224

afmetingen (mm)	Art.
117 x 287 x 440	EDM.SG.050.227
117 x 141 x 440	EDM.SG.050.230
310 x 625 x 248	EDM.SG.050.205
310 x 310 x 248	EDM.SG.050.208
152 x 625 x 248	EDM.SG.050.211
152 x 310 x 248	EDM.SG.050.214
152 x 152 x 248	EDM.SG.050.217
240 x 580 x 216	EDM.SG.050.219
240 x 287 x 216	EDM.SG.050.222
117 x 580 x 216	EDM.SG.050.225
117 x 287 x 216	EDM.SG.050.228
117 x 141 x 216	EDM.SG.050.231

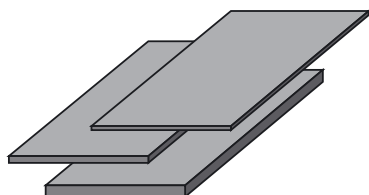

STANDAARD PLAAT : Gezaagd - tolerantie op de dikte : 0 / + 2 mm - 1 rechte zijde.
Geslepen - tolerantie op de dikte : + / - 0,05 mm.

afmetingen (mm)	Art. EDM.SG.050...	
	gezaagd	geslepen
625 x 310 x 10	...232	...252
625 x 310 x 20	...233	...253
625 x 310 x 30	...234	...254
625 x 310 x 40	...235	...255
625 x 310 x 50	...236	...256
625 x 310 x 60	...237	...257
625 x 310 x 70	...238	...258
625 x 310 x 80	...239	...259
625 x 310 x 90	...240	...260
625 x 310 x 100	...241	...261

afmetingen (mm)	Art. EDM.SG.050...	
	gezaagd	geslepen
310 x 310 x 10	...242	...262
310 x 310 x 20	...243	...263
310 x 310 x 30	...244	...264
310 x 310 x 40	...245	...265
310 x 310 x 50	...246	...266
310 x 310 x 60	...247	...267
310 x 310 x 70	...248	...268
310 x 310 x 80	...249	...269
310 x 310 x 90	...250	...270
310 x 310 x 100	...251	...271

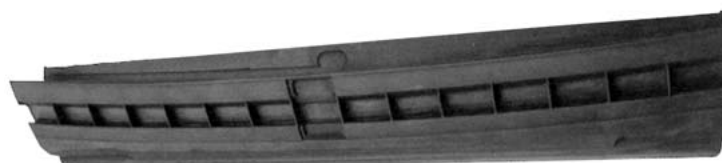

**GRAFJET "TOYO TANSO"
ISEM 08**

Art. EDM.SG.050

soortelijk gewicht	hardheid	elekt. weerstand	mechan. weerstand	korrelgrootte
1,77 g/cm ³	65 Shore D	1450 u Ω cm	750 kgf/cm ²	8 mu

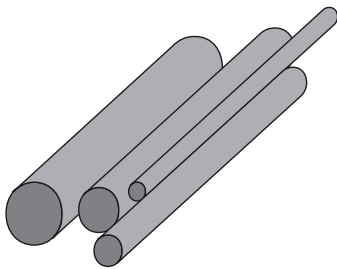

CILINDERS :

Tolerantie Ø / 0 / + 0,2 mm, tolerantie op de lengte : 0 / + 10 mm

Ø x L 300 mm	Art.	Ø x L 300 mm	Art.
10	EDM.SG.050.272	70	EDM.SG.050.282
15	EDM.SG.050.273	75	EDM.SG.050.283
20	EDM.SG.050.274	80	EDM.SG.050.284
25	EDM.SG.050.275	90	EDM.SG.050.285
30	EDM.SG.050.276	100	EDM.SG.050.286
35	EDM.SG.050.277	120	EDM.SG.050.287
40	EDM.SG.050.278	125	EDM.SG.050.288
45	EDM.SG.050.279	150	EDM.SG.050.289
50	EDM.SG.050.280	175	EDM.SG.050.290
60	EDM.SG.050.281	200	EDM.SG.050.291

GEPROFILEERDE ELEKTRODE :

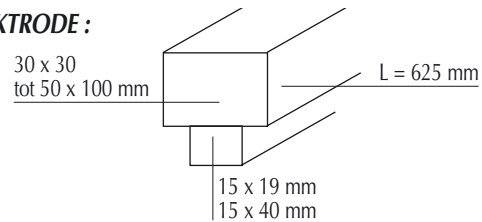

**GRAFJET "TOYO TANSO"
TTK 50**

Art. EDM.SG.040

soortelijk gewicht	hardheid	elekt. weerstand	mechan. weerstand	korrelgrootte
1,80 g/cm ³	72 Shore	1430 u Ω cm	630 kgf/cm ²	7 mu

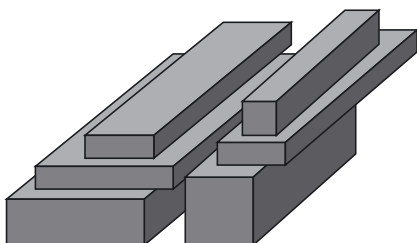

STANDAARD BLOK :

(snel leverbaar - beste prijs per dm³)

afmetingen (mm)	Art.
290 x 500 x 1000	EDM.SG.040.001
290 x 590 x 502	EDM.SG.040.016
290 x 293 x 1010	EDM.SG.040.017
143 x 590 x 1010	EDM.SG.040.004

STANDAARD SNEDE :

afmetingen (mm)	Art.
290 x 293 x 502	EDM.SG.040.005
290 x 590 x 248	EDM.SG.040.006
290 x 293 x 248	EDM.SG.040.009
143 x 293 x 1010	EDM.SG.040.008
143 x 145 x 1010	EDM.SG.040.011
143 x 590 x 502	EDM.SG.040.007
143 x 293 x 502	EDM.SG.040.010
143 x 145 x 502	EDM.SG.040.013
143 x 590 x 248	EDM.SG.040.012
143 x 293 x 248	EDM.SG.040.014
143 x 145 x 248	EDM.SG.040.015

**GRAFIET "TOYO TANSO"
ISO 63**

Art. EDM.SG.170

soortelijk gewicht	hardheid	elekt. weerstand	mechan. weerstand	korrelgrootte
1,82 g/cm ³	80 Shore D	1550 u Ω cm	770 kgf/cm ²	< 5 mu

STANDAARD BLOK :
(snel leverbaar - beste prijs per dm³)

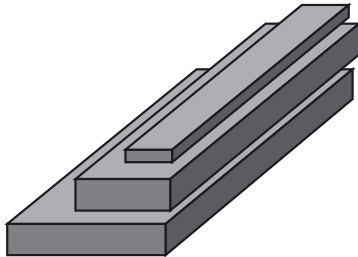

afmetingen (mm)	Art.
235 x 545 x 1010	EDM.SG.170.001
235 x 545 x 502	EDM.SG.170.004
235 x 270 x 502	EDM.SG.170.007
185 x 455 x 1010	EDM.SG.170.003
185 x 455 x 502	EDM.SG.170.018
185 x 225 x 502	EDM.SG.170.021

STANDAARD SNEDE :

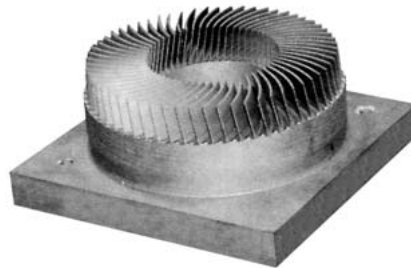

afmetingen (mm)	Art.
235 x 270 x 1010	EDM.SG.170.006
185 x 225 x 1010	EDM.SG.170.020
115 x 545 x 1010	EDM.SG.170.009
115 x 270 x 1010	EDM.SG.170.012
115 x 132 x 1010	EDM.SG.170.015
90 x 455 x 1010	EDM.SG.170.023
90 x 225 x 1010	EDM.SG.170.026
90 x 110 x 1010	EDM.SG.170.029
115 x 545 x 502	EDM.SG.170.010
115 x 270 x 502	EDM.SG.170.013
115 x 132 x 502	EDM.SG.170.016
90 x 455 x 502	EDM.SG.170.024
90 x 225 x 502	EDM.SG.170.027
90 x 110 x 502	EDM.SG.170.030
235 x 545 x 248	EDM.SG.170.005
235 x 270 x 248	EDM.SG.170.008
185 x 455 x 248	EDM.SG.170.019
185 x 225 x 248	EDM.SG.170.022
115 x 545 x 248	EDM.SG.170.011
115 x 270 x 248	EDM.SG.170.014
115 x 132 x 248	EDM.SG.170.017
90 x 455 x 248	EDM.SG.170.025
90 x 225 x 248	EDM.SG.170.028
90 x 110 x 248	EDM.SG.170.031

STANDAARD PLAAT : Gezaagd - tolerantie op de dikte : 0 / + 2 mm - 1 rechte zijde.
Geslepen - tolerantie op de dikte : + / - 0,05 mm.

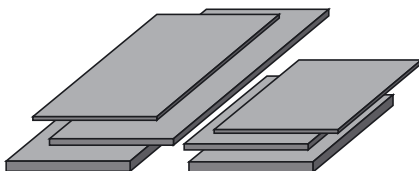

afmetingen (mm)	Art. EDM.SG.170...	
	gezaagd	geslepen
545 x 235 x 10	...032	...052
545 x 235 x 20	...033	...053
545 x 235 x 30	...034	...054
545 x 235 x 40	...035	...055
545 x 235 x 50	...036	...056
545 x 235 x 60	...037	...057
545 x 235 x 70	...038	...058
545 x 235 x 80	...039	...059
545 x 235 x 90	...040	...060
545 x 235 x 100	...041	...061

afmetingen (mm)	Art. EDM.SG.170...	
	gezaagd	geslepen
270 x 235 x 10	...042	...062
270 x 235 x 20	...043	...063
270 x 235 x 30	...044	...064
270 x 235 x 40	...045	...065
270 x 235 x 50	...046	...066
270 x 235 x 60	...047	...067
270 x 235 x 70	...048	...068
270 x 235 x 80	...049	...069
270 x 235 x 90	...050	...070
270 x 235 x 100	...051	...071

**GRAFJET "TOYO TANSO"
ISO 63**

Art. EDM.SG.170

soortelijk gewicht	hardheid	elekt. weerstand	mechan. weerstand	korrelgrootte
1,82 g/cm ³	80 Shore D	1550 u Ω cm	770 kgf/cm ²	< 5 mu

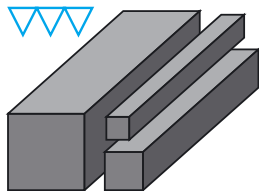

GESLEPEN VIERKANTEN :

Toleranties : $\nabla 0 / + 0,05$ mm. Lengte : 235 mm.

afm. (mm)	Art.
5 x 5	EDM.SG.170.108
10 x 10	EDM.SG.170.109
15 x 15	EDM.SG.170.110
20 x 20	EDM.SG.170.111

afm. (mm)	Art.
25 x 25	EDM.SG.170.112
30 x 30	EDM.SG.170.113
40 x 40	EDM.SG.170.114
50 x 50	EDM.SG.170.115

afm. (mm)	Art.
14,95 x 14,95	EDM.SG.170.116 met soeverein voor speciale montages
24,95 x 24,95	EDM.SG.170.126 met soeverein voor speciale montages

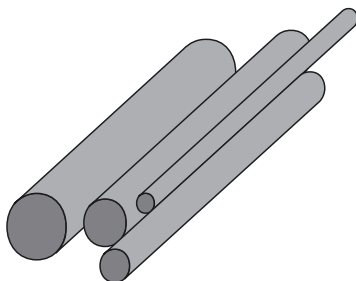

CILINDER :

- $\varnothing \leq 10$ mm - tolerantie \varnothing : 0 / + 0,1 mm,
- $\varnothing > 10$ mm - tolerantie \varnothing : 0 / + 0,2 mm,
- tolerantie op de lengte : 0 / + 10 mm.

\varnothing x L 300 mm	Art.
5	EDM.SG.170.092
6	EDM.SG.170.093
8	EDM.SG.170.094
10	EDM.SG.170.072
15	EDM.SG.170.073
20	EDM.SG.170.074
25	EDM.SG.170.075
30	EDM.SG.170.076
35	EDM.SG.170.077
40	EDM.SG.170.078
45	EDM.SG.170.079
50	EDM.SG.170.080

\varnothing x L 300 mm	Art.
60	EDM.SG.170.081
70	EDM.SG.170.082
75	EDM.SG.170.083
80	EDM.SG.170.084
90	EDM.SG.170.085
100	EDM.SG.170.086
120	EDM.SG.170.087
125	EDM.SG.170.088
150	EDM.SG.170.089
175	EDM.SG.170.090
185	EDM.SG.170.091

GEPROFILEERDE ELEKTRODE :

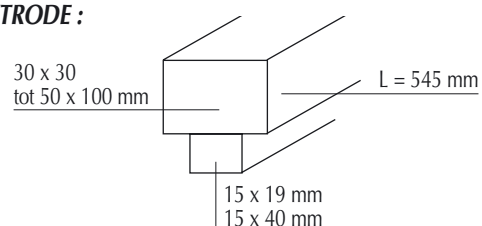

**GRAFJET "TOYO TANSO"
TTK 04**

Art. EDM.SG.100

soortelijk gewicht	hardheid	elekt. weerstand	mechan. weerstand	korrelgrootte
1,79 g/cm ³	65 Shore D	1245 u Ω cm	740 kgf/cm ²	< 4 mu

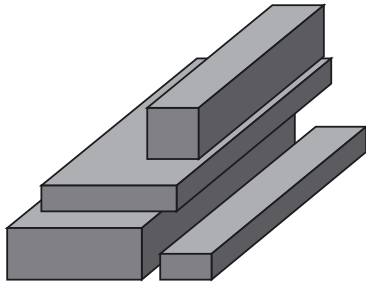

STANDAARD BLOK :
(snel leverbaar - beste prijs per dm³)

afmetingen (mm)	Art.
152 x 305 x 610	EDM.SG.100.001
152 x 152 x 610	EDM.SG.100.002
152 x 305 x 300	EDM.SG.100.003

STANDAARD SNEDE :

afmetingen (mm)	Art.
73 x 305 x 610	EDM.SG.100.004
73 x 152 x 610	EDM.SG.100.007
152 x 152 x 300	EDM.SG.100.005
152 x 305 x 148	EDM.SG.100.006
152 x 152 x 148	EDM.SG.100.009
73 x 305 x 300	EDM.SG.100.008
73 x 152 x 300	EDM.SG.100.010
73 x 305 x 148	EDM.SG.100.011

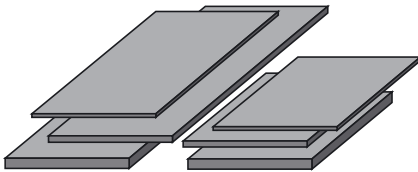

STANDAARD PLAAT : Gezaagd - tolerantie op de dikte : 0 / + 2 mm - 1 rechte zijde.
Geslepen - tolerantie op de dikte : + / - 0,05 mm.

afmetingen (mm)	Art. EDM.SG.100...	
	gezaagd	geslepen
152 x 152 x 3	...012	...028
152 x 152 x 4	...013	...029
152 x 152 x 5	...014	...030
152 x 152 x 6	...015	...031
152 x 152 x 7	...016	...032
152 x 152 x 8	...017	...033
152 x 152 x 9	...018	...034
152 x 152 x 10	...019	...035

afmetingen (mm)	Art. EDM.SG.100...	
	gezaagd	geslepen
152 x 152 x 15	...020	...036
152 x 152 x 20	...021	...037
152 x 152 x 25	...022	...038
152 x 152 x 30	...023	...039
152 x 152 x 35	...024	...040
152 x 152 x 40	...025	...041
152 x 152 x 45	...026	...042
152 x 152 x 50	...027	...043

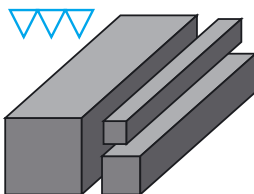

GESLEPEN VIERKANTEN :
Toleranties : ∇ 0 / + 0,05 mm

afmetingen (mm)	Art.
5 x 5 x 300	EDM.SG.100.044
10 x 10 x 300	EDM.SG.100.045
15 x 15 x 300	EDM.SG.100.046
20 x 20 x 300	EDM.SG.100.047

afmetingen (mm)	Art.
25 x 25 x 300	EDM.SG.100.048
30 x 30 x 300	EDM.SG.100.049
40 x 40 x 300	EDM.SG.100.050
50 x 50 x 300	EDM.SG.100.051

afm. (mm)	Art.
14,95 x 14,95 x 300	EDM.SG.100.052 met soeverein voor speciale montages.
24,95 x 24,95 x 300	EDM.SG.100.053 met soeverein voor speciale montages.

**GRAFJET "TOYO TANSO"
TTK 04**

Art. EDM.SG.100

soortelijk gewicht	hardheid	elekt. weerstand	mechan. weerstand	korrelgrootte
1,79 g/cm ³	65 Shore D	1245 u Ω cm	770 kgf/cm ²	< 4 mu

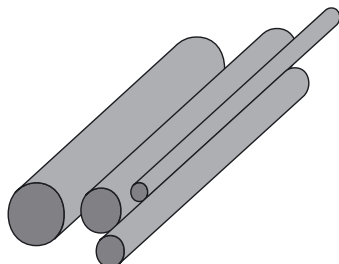

CILINDER :

Ø ≤ 10 mm - tolerantie Ø : 0 / + 0,1 mm,

Ø > 10 mm - tolerantie Ø : 0 / + 0,2 mm.

Tolerantie op de lengte : 0 / + 10 mm.

Op aanvraag : geslepen cilinder, tolerantie Ø 0 / + 0,05, tolerantie op de lengte : 0 / + 3 %

Ø x L 300 mm	Art.
3	EDM.SG.100.054
4	EDM.SG.100.055
5	EDM.SG.100.056
6	EDM.SG.100.057
8	EDM.SG.100.058
10	EDM.SG.100.059
15	EDM.SG.100.060
20	EDM.SG.100.061

Ø x L 300 mm	Art.
25	EDM.SG.100.062
30	EDM.SG.100.063
35	EDM.SG.100.064
40	EDM.SG.100.065
45	EDM.SG.100.066
50	EDM.SG.100.067
60	EDM.SG.100.068
70	EDM.SG.100.069

Ø x L 300 mm	Art.
75	EDM.SG.100.070
80	EDM.SG.100.071
90	EDM.SG.100.072
100	EDM.SG.100.073
120	EDM.SG.100.074
130	EDM.SG.100.075
140	EDM.SG.100.076

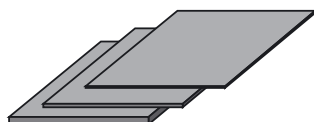

GESLEPEN FOLIE :

Tolerantie op de dikte : +/- 0,02 mm, afm. 152 x 152 mm.

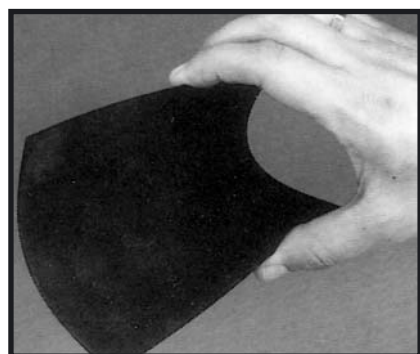

dikte mm	Art.
0,1	EDM.SG.100.094
0,2	EDM.SG.100.095
0,3	EDM.SG.100.096
0,4	EDM.SG.100.097
0,5	EDM.SG.100.098
0,6	EDM.SG.100.099
0,7	EDM.SG.100.100
0,8	EDM.SG.100.101
0,9	EDM.SG.100.102
1,0	EDM.SG.100.103
1,1	EDM.SG.100.104
1,2	EDM.SG.100.105
1,3	EDM.SG.100.106
1,4	EDM.SG.100.107
1,5	EDM.SG.100.108

dikte mm	Art.
1,6	EDM.SG.100.109
1,7	EDM.SG.100.110
1,8	EDM.SG.100.111
1,9	EDM.SG.100.112
2,0	EDM.SG.100.113
2,1	EDM.SG.100.114
2,2	EDM.SG.100.115
2,3	EDM.SG.100.116
2,4	EDM.SG.100.117
2,5	EDM.SG.100.118
2,6	EDM.SG.100.119
2,7	EDM.SG.100.120
2,8	EDM.SG.100.121
2,9	EDM.SG.100.122

GEPROFILEERDE ELEKTRODE :

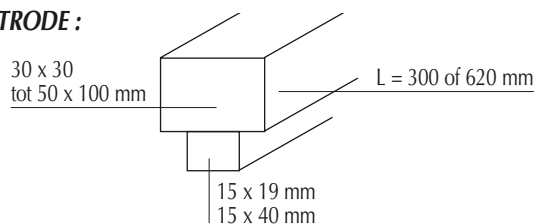

**GRAFIET "TOYO TANSO"
ISO 95**

Art. EDM.SG.210

soortelijk gewicht	hardheid	elekt. weerstand	mechan. weerstand	korrelgrootte
1,90 g/cm ³	85 Shore D	1350 u Ω cm	950 kgf/cm ²	1 mu

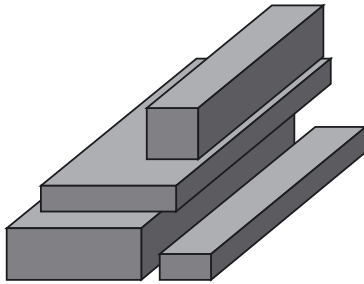

STANDAARD BLOK :

afmetingen (mm)	Art.
76 x 157 x 450	EDM.SG.210.001
76 x 157 x 220	EDM.SG.210.002
76 x 76 x 450	EDM.SG.210.003

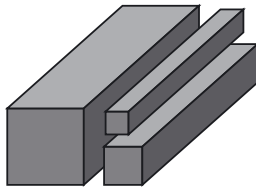

GESLEPEN VIERKANT :

Tolerantie 0 / + 0,05 mm.

Afmetingen : 14,95 x 14,95 x 157 mm : Art. EDM.SG.210.005

Met soeverein voor speciale montages.

**KOPER-GRAFIET "TOYO TANSO"
TTK.04.C**

Art. EDM.SG.450

soortelijk gewicht	hardheid	elekt. weerstand	mechan. weerstand	korrelgrootte
2,90 g/cm ³	60 Shore D	254 u Ω cm	1070 kgf/cm ²	< 4 mu

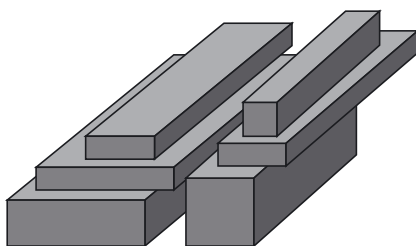

STANDAARD BLOK :

(snel leverbaar - beste prijs per dm³)

afmetingen (mm)	Art.
75 x 150 x 450	EDM.SG.450.002
75 x 150 x 305	EDM.SG.450.001

STANDAARD SNEDE :

afmetingen (mm)	Art.
75 x 150 x 223	EDM.SG.450.003
75 x 150 x 148	EDM.SG.450.005
75 x 73 x 450	EDM.SG.450.004
75 x 73 x 300	EDM.SG.450.006

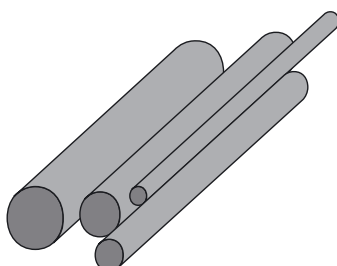

CILINDER : Tolerantie Ø / 0 / + 0,2 mm, tolerantie op de lengte : 0 / + 10 mm.

Op aanvraag : geslepen cilinder, tolerantie Ø +/- 0,02 mm, tolerantie op de lengte : 0 / + 3 %.

Ø x L 300 mm	Art.
10	EDM.SG.450.010
15	EDM.SG.450.011
20	EDM.SG.450.012
25	EDM.SG.450.013
30	EDM.SG.450.014

Ø x L 300 mm	Art.
35	EDM.SG.450.015
40	EDM.SG.450.016
45	EDM.SG.450.017
50	EDM.SG.450.018
60	EDM.SG.450.019

**CONISCHE GRAFIET ELECTRODE
"TOYO TANSO"**

Art. EDM.SG.170 / 100

CONISCHE ELECTRODE - ISO 63

Tolerantie : A en C : +/- 0,03 mm, α : +/- 4'

soortelijk gewicht	hardheid	elekt. weerstand	mechan. weerstand	korrelgrootte
1,82 g/cm ³	80 Shore D	1550 u Ω cm	770 kgf/cm ²	< 5 mu

α	A (mm)	B (mm)	C (mm)	Art. D x E : 185 x 110 mm
0,5°	1	86	2,5	EDM.SG.170.117
0,5°	2	86	3,5	EDM.SG.170.118
1°	1	86	4	EDM.SG.170.119
1°	2	86	5	EDM.SG.170.120
1,5°	1	76,5	5	EDM.SG.170.121
1,5°	2	76,5	6	EDM.SG.170.122
2°	1	72	6	EDM.SG.170.123
2°	2	72	7	EDM.SG.170.124
0,5°	0,6	86	2,1	EDM.SG.170.125

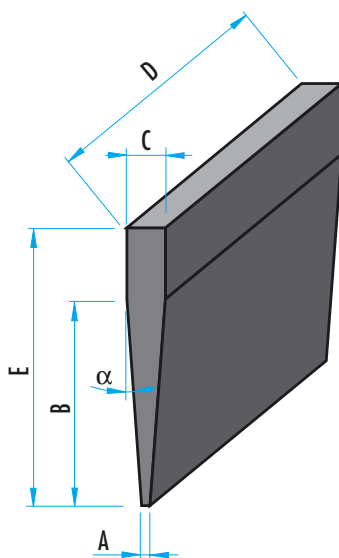

CONISCHE ELECTRODE - TTK.04

Tolerantie : A en C : +/- 0,03 mm, α : +/- 4'

soortelijk gewicht	hardheid	elekt. weerstand	mechan. weerstand	korrelgrootte
1,79 g/cm ³	65 Shore D	1245 u Ω cm	740 kgf/cm ²	< 4 mu

α	A (mm)	B (mm)	C (mm)	Art. D x E : 150 x 100 mm
0,5°	1	86	2,5	EDM.SG.100.086
0,5°	2	86	3,5	EDM.SG.100.087
1°	1	86	4	EDM.SG.100.088
1°	2	86	5	EDM.SG.100.089
1,5°	1	76,5	5	EDM.SG.100.090
1,5°	2	76,5	6	EDM.SG.100.091
2°	1	72	6	EDM.SG.100.092
2°	2	72	7	EDM.SG.100.093

GRAFIETSTAAF

Art. EDM.SG.PC3

soortelijk gewicht	hardheid	elekt. weerstand	mechan. weerstand	korrelgrootte
1,83 g/cm ³	70 Shore D	1500 u Ω cm	915 kgf/cm ²	2,5 mu

Afmetingen : Ø x L = 150 mm.

Afmetingen : Ø x L = 300 mm.

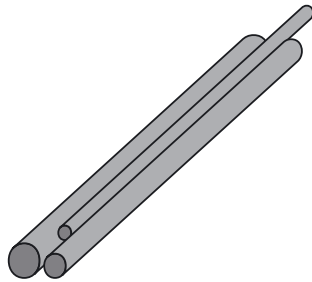

Ø (mm)	Art.
0,46	EDM.SG.PC3.001
0,58	EDM.SG.PC3.002
0,71	EDM.SG.PC3.003
0,84	EDM.SG.PC3.004
0,96	EDM.SG.PC3.005
1,09	EDM.SG.PS3.006
1,22	EDM.SG.PC3.007
1,35	EDM.SG.PC3.008
1,47	EDM.SG.PC3.009
1,55	EDM.SG.PC3.010
2,03	EDM.SG.PC3.011
2,54	EDM.SG.PC3.012
3,05	EDM.SG.PC3.013

Ø (mm)	Art.
0,46	EDM.SG.PC3.101
0,58	EDM.SG.PC3.102
0,71	EDM.SG.PC3.103
0,84	EDM.SG.PC3.104
0,96	EDM.SG.PC3.105
1,09	EDM.SG.PC3.106
1,22	EDM.SG.PC3.107
1,35	EDM.SG.PC3.108
1,47	EDM.SG.PC3.109
1,55	EDM.SG.PC3.110
2,03	EDM.SG.PC3.111
2,54	EDM.SG.PC3.112
3,05	EDM.SG.PC3.113

GRAFIETBUIS

Art. EDM.SG.P3

soortelijk gewicht	hardheid	elekt. weerstand	mechan. weerstand	korrelgrootte
1,83 g/cm ³	70 Shore D	1500 u Ω cm	915 kgf/cm ²	2,5 mu

Tolerantie Ø : ± 0,03 mm - L = 150 mm

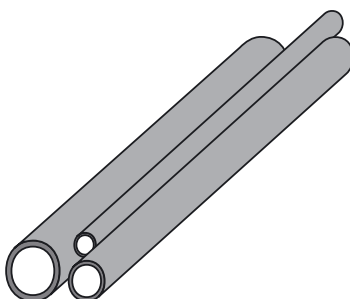

Ø buiten	Ø binnen	Art.
3	1,0	EDM.SG.P3.001
4	1,0	EDM.SG.P3.002
5	1,5	EDM.SG.P3.003
6	3,1	EDM.SG.P3.004
7	4,0	EDM.SG.P3.005
8	5,0	EDM.SG.P3.006
9	5,0	EDM.SG.P3.007
10	6,0	EDM.SG.P3.008
11	6,0	EDM.SG.P3.009
12	9,5	EDM.SG.P3.010

Andere Ø en afmetingen op aanvraag.